

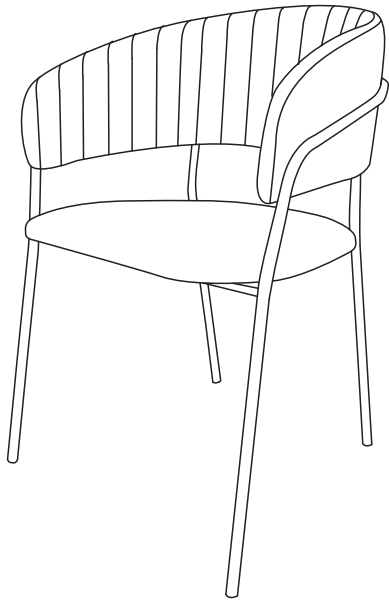





ASSEMBLY INSTRUCTIONS



A x4	B x1	C x4	D x3
			

E x1		
		

1

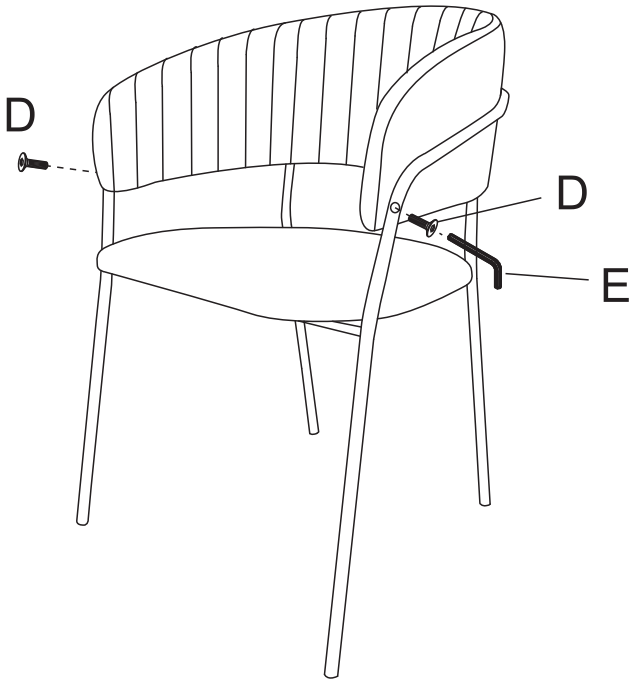

2

