

# ASSEMBLY INSTRUCTIONS

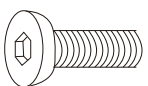

Ax4

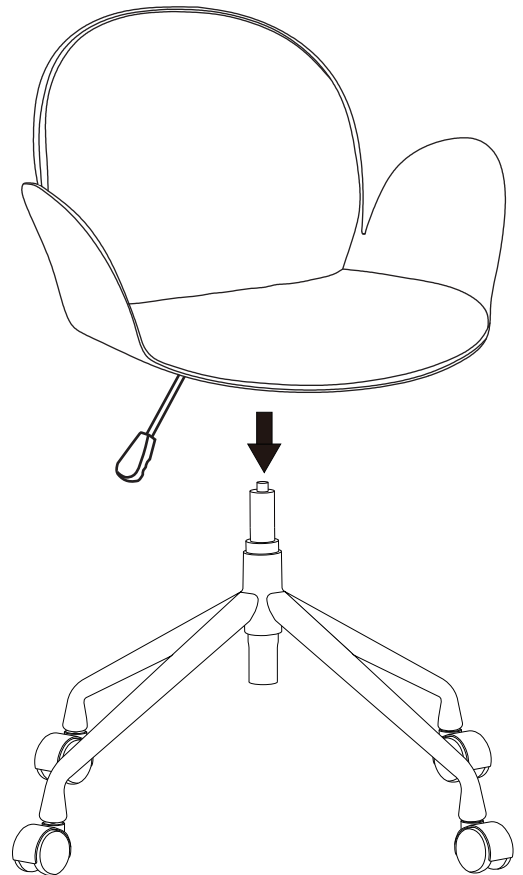
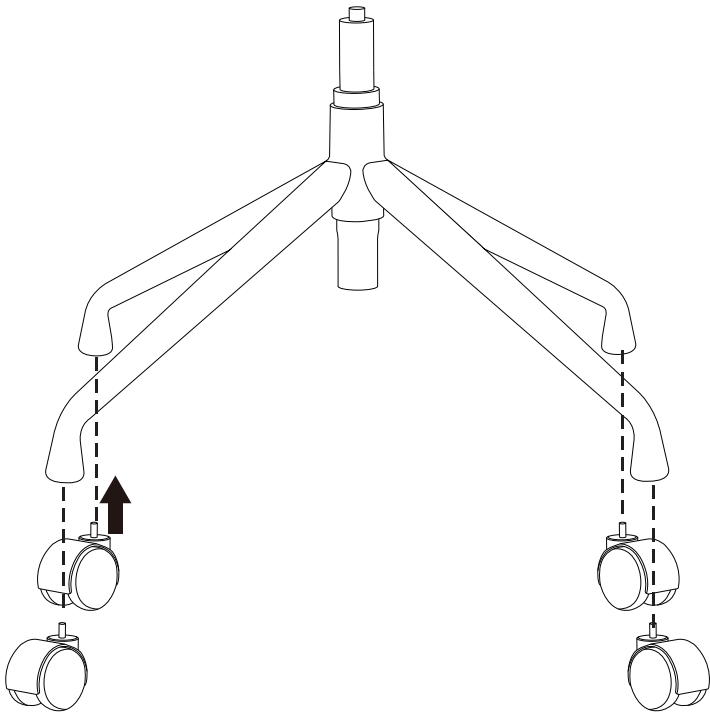
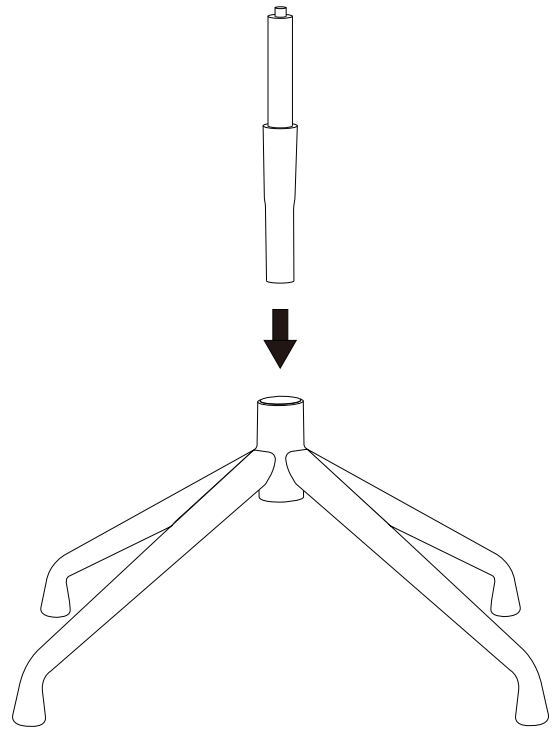
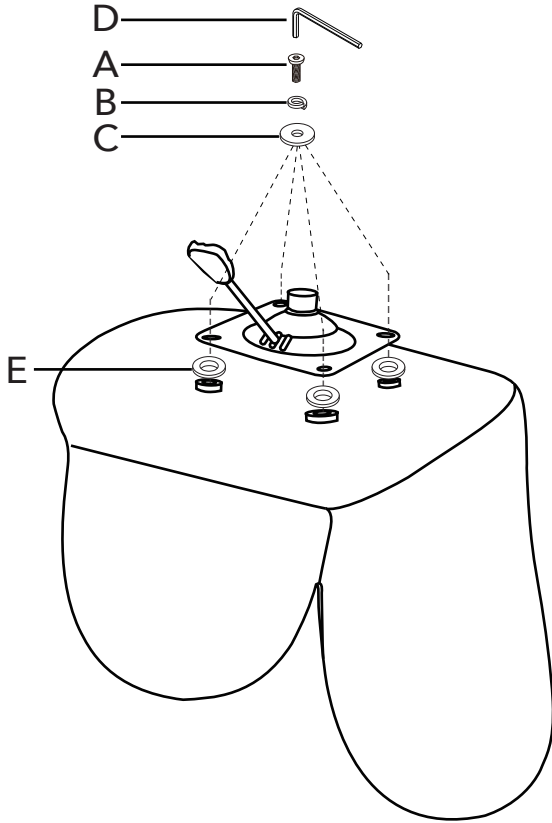
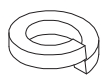

Bx4



Cx4

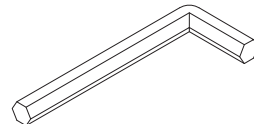

Dx1

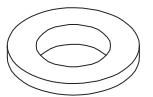

Ex4